

siteco

Siteco Connect



Possible applications Shelf/ high-bay storage

Copyright 2020 by SITECO



SITECO_Connect_app_ex_1.1...1.3_shelf_high-bay storage_V.1_EN_2022-02-16_CRK HK

Shelf/ high-bay warehouse

Possible applications			
Application	Shelf/ high-bay warehouse		
Control	local control SITECO Connect	central control SITECO Connect 22	central control SITECO Connect 11
	Example 1.3	Example 1.2	Example 1.1
Luminaire	Licross® trunking 	Licross® trunking 	Licross® trunking 
Basic energy-saving function			
Daylight Threshold & Motion Detection	•	•	•
manual control		•	•
Basic lighting during absence	•	•	•
Additional functions			
Flexible grouping		•	•
Inventory lighting	•	•	•
Transit lighting		•	•
predictive maintenance			•
Energy monitoring			optional
Services			optional
Building or site networking			optional
Possible applications			
Link to	Page 3	Page 7	Page 11



Example 1.3

**Shelf/ high-bay
warehouse**

Licross® trunking

local control

1.3 Shelf/high bay warehouse

local control



Efficiency through integrated energy-saving basic functions



Safety through sensors with high detection quality



Simplicity due to minimized cabling and commissioning effort



Modularity and **freedom** in planning thanks to the Licross® family concept



Retrofittability through modular sensor interfaces in existing systems



Future-proof through the use of open Standards

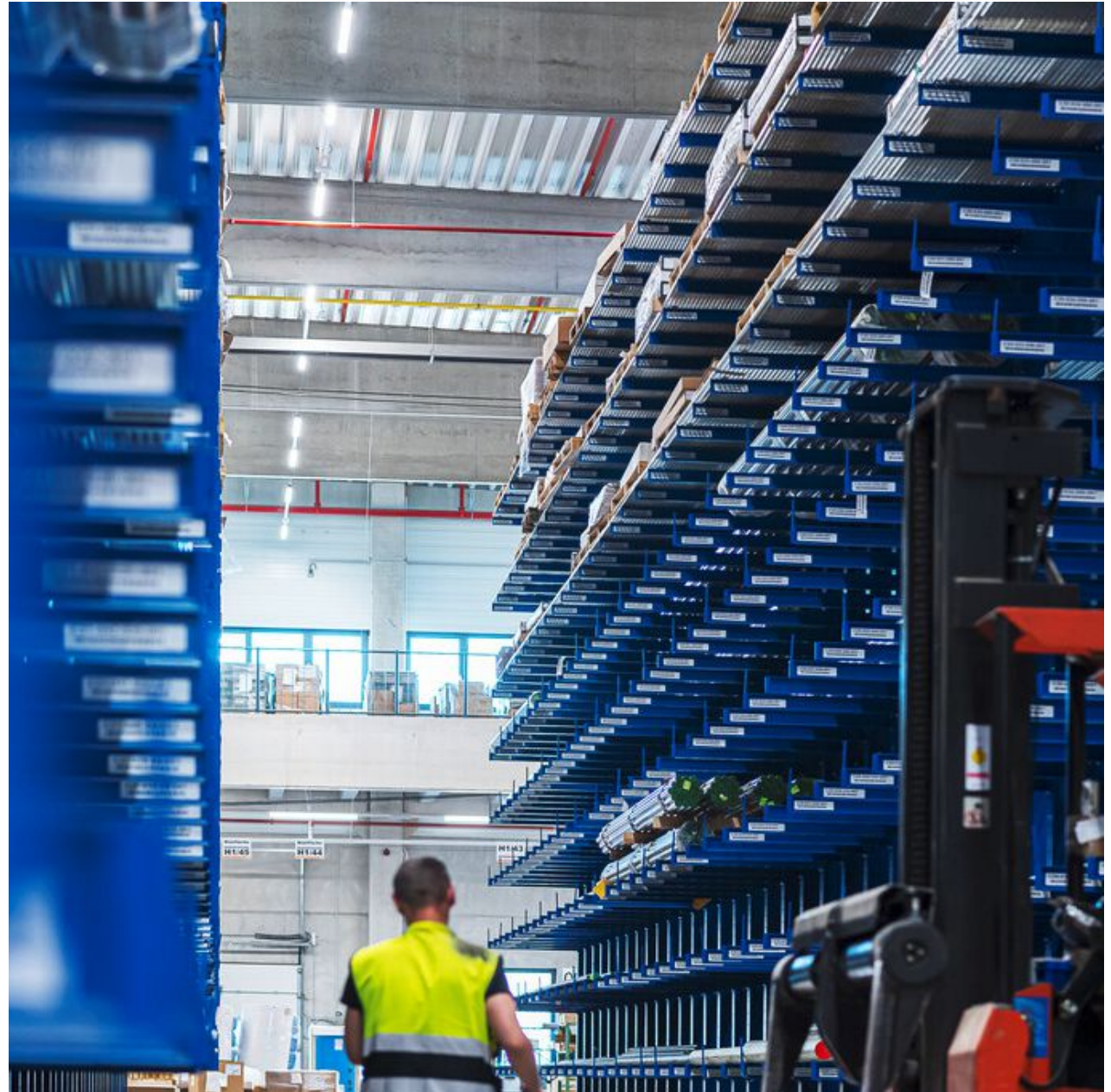

1.3 Shelf/high bay warehouse local control

Example (LPH = 14m, length = 60m, width = 4m)

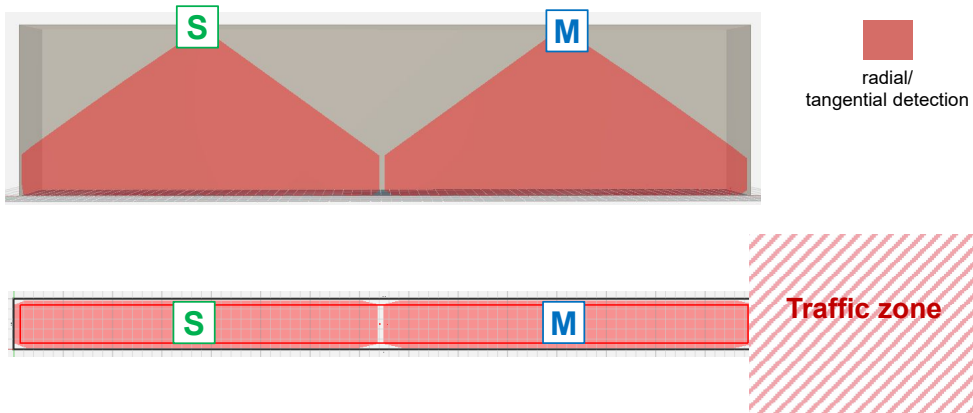

Keep in mind when planning:

- **S** = immediate detection on entry or entry
 - no detection of cross traffic on traffic zone
 - **M** = Master sensor in the darkest position of the lighting group
- For other mounting heights, please refer to the table of mounting heights!

Which products are needed?		
Designation	Function	Order no.
Licross® luminaire DALI & rail		specific
Licross® Sensor Interface MD + Sensor Head PR2-M	Master M	56TL1FCMA 59US1HXMPR2A
Licross® Sensor Interface S + Sensor Head PR2-S	Slave S	56TL1FCSA 59US1HXSPR2A
Smart Remote	Commissioning	59UC3RCA

Maximum system sizes				
# DALI ECG	Max. 30	Max. 27	Max. 24	Max. 21
# Master	1x M	1x M	1x M	1x M
# Slave	0x S	1x S	2x S	3x S

Sensor Head			
Designation	MH	R	T
PR2 (Relux-Article-#010591)	14m	30x4m	30x4m
	12m	30x4m	30x4m
	10m	25x4m	25x4m
	8m	20x4m	20x4m
	6m	15x4m	15x4m
	4m	10x4m	10x4m

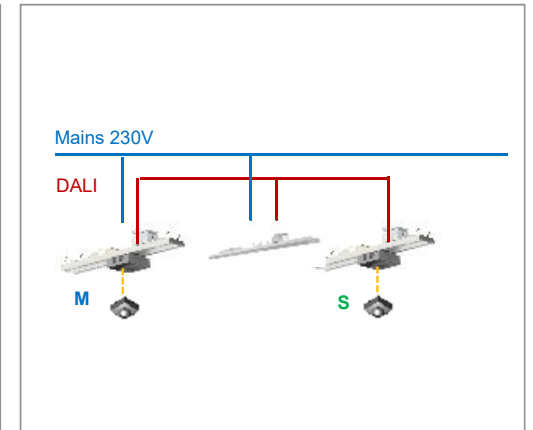

1.3 Shelf/high bay warehouse local control

Scheme/Schemen

Lokale Steuerung - dimmbar
Locally control - dimmable

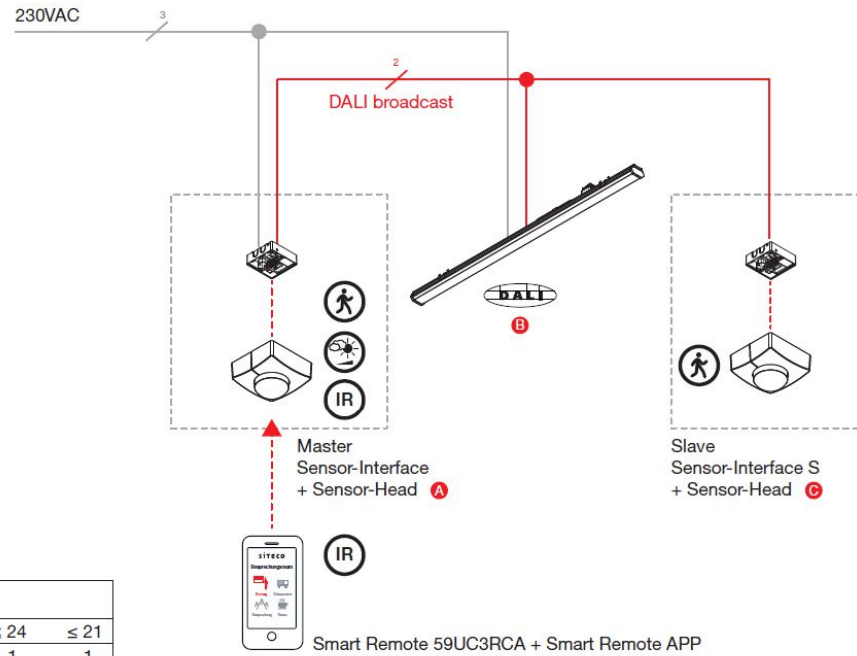

Systemgröße/System size				
DALI-EVG (B)	≤ 30	≤ 27	≤ 24	≤ 21
Master (A)	1	1	1	1
Slave (C)	0	1	2	3

Die obige Darstellung zeigt nur einen exemplarischen Schaltplan eines Lichtmanagementsystems. Für einen konkreten Anwendungsfall ist zwingend eine individuelle Planung (insbesondere Leitungs- und Stromkreisdimensionierungen, Leitungsarten, Brandschottungen, Trassenführungen, etc.) durch qualifiziertes Personal erforderlich. Die Siteco GmbH übernimmt keinerlei Haftung für die Richtigkeit der obigen Darstellung

The illustration above only shows an exemplary circuit diagram of a light management system. For a specific application, individual planning (in particular line and circuit dimensions, line types, fire barriers, cable routing, etc.) a qualified personnel is essential. The SITECO GmbH assumes no liability for the correctness of the above representation.

1.3 Shelf/high bay warehouse local control

Stromlaufplan/wiring diagram

**Lokale Steuerung -
dimmbar**
**Locally control -
dimmable**

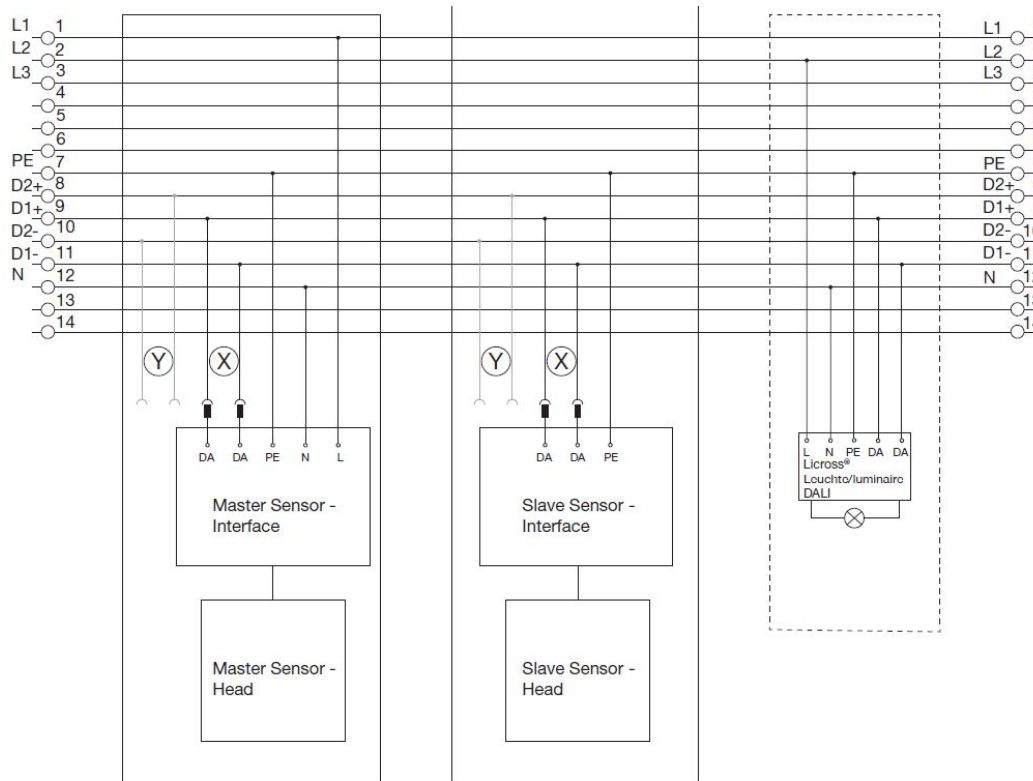

Die obige Darstellung zeigt nur einen exemplarischen Schaltplan eines Lichtmanagementsystems. Für einen konkreten Anwendungsfall ist zwingend eine individuelle Planung (insbesondere Leitungs- und Stromkreisdimensionierungen, Leitungsarten, Brandschottungen, Trassenführungen, etc.) durch qualifiziertes Personal erforderlich. Die Siteco GmbH übernimmt keinerlei Haftung für die Richtigkeit der obigen Darstellung

The illustration above only shows an exemplary circuit diagram of a light management system. For a specific application, individual planning (in particular line and circuit dimensions, line types, fire barriers, cable routing, etc.) a qualified personnel is essential. The SITECO GmbH assumes no liability for the correctness of the above representation.



Example 1.2

**Shelf/ high-bay
warehouse**

Licross® trunking

**central control
SITECO Connect 22**

1.2 Shelf/high bay storage SITECO Connect 22

- ▶ **Efficiency** through integrated energy-saving basic functions
- ▶ **Safety** through sensors with high detection quality
- ▶ **Modularity** and **freedom** in planning thanks to the Licross® family concept
- ▶ **Retrofittability** through modular sensor interfaces in existing systems
- ▶ **Future-proof** through the use of open Standards
- ▶ Maximum **flexibility** through individual addressing, thus adaptation to changing needs.



1.2 Shelf/high bay storage system SITECO Connect 22

Example (LPH = 14m, length = 60m, width = 4m)

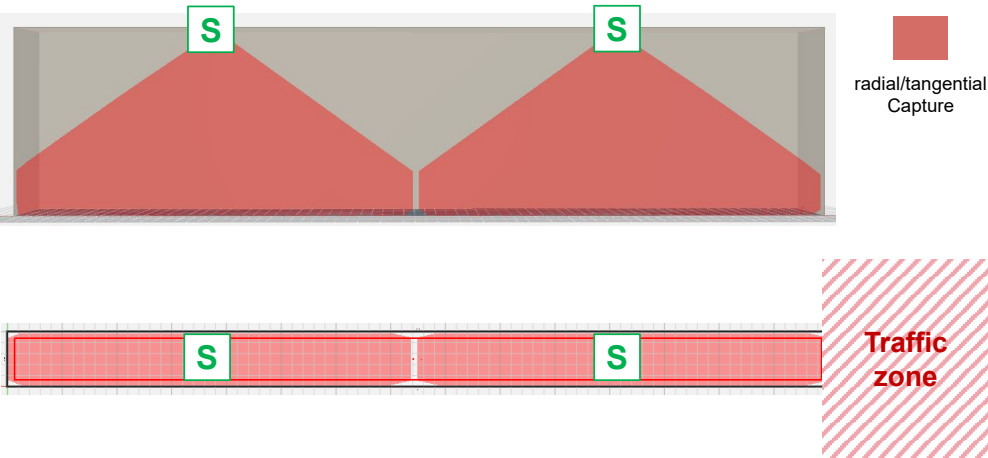

Keep in mind when planning:

- **S** = immediate detection on entry or entry
- no detection of cross traffic on traffic zone

For other mounting heights, please refer to the table of mounting heights!

Which products are needed?

Components	Function	Order no.
Licross® luminaire DALI & rail		specific
Licross® Sensor Interface S + Sensor Head PR2-S	DALI 2	56TL1FCSA 59US1HXSPR2A
SITECO Connect 22 Controller	Two DALI lines	5LZ904712A
Push-button interface 4-fold, 4 DI	DALI 2	5LZ930303
Services		
Commissioning		at cost

SITECO Connect 22 - maximum system sizes

# DALI ECG	max. 64 per DALI 2 line
# Sensors	max. 64 sensor functions per DALI 2 line (Attention, observe current consumption! max. output current of DALI control must not be exceeded!)

Sensor Head	MH	R	T
PR2	14m	30x4m	30x4m
	12m	30x4m	30x4m
PR2 (Relux-Article-#010591)	10m	25x4m	25x4m
	8m	20x4m	20x4m
	6m	15x4m	15x4m
	4m	10x4m	10x4m

Sub-distribution
SITECO Connect 11 control with DALI 2 interface

Elektrotechnisches Schema

1.2 Shelf/high bay storage system

SITECO Connect 22

Siteco Connect 22

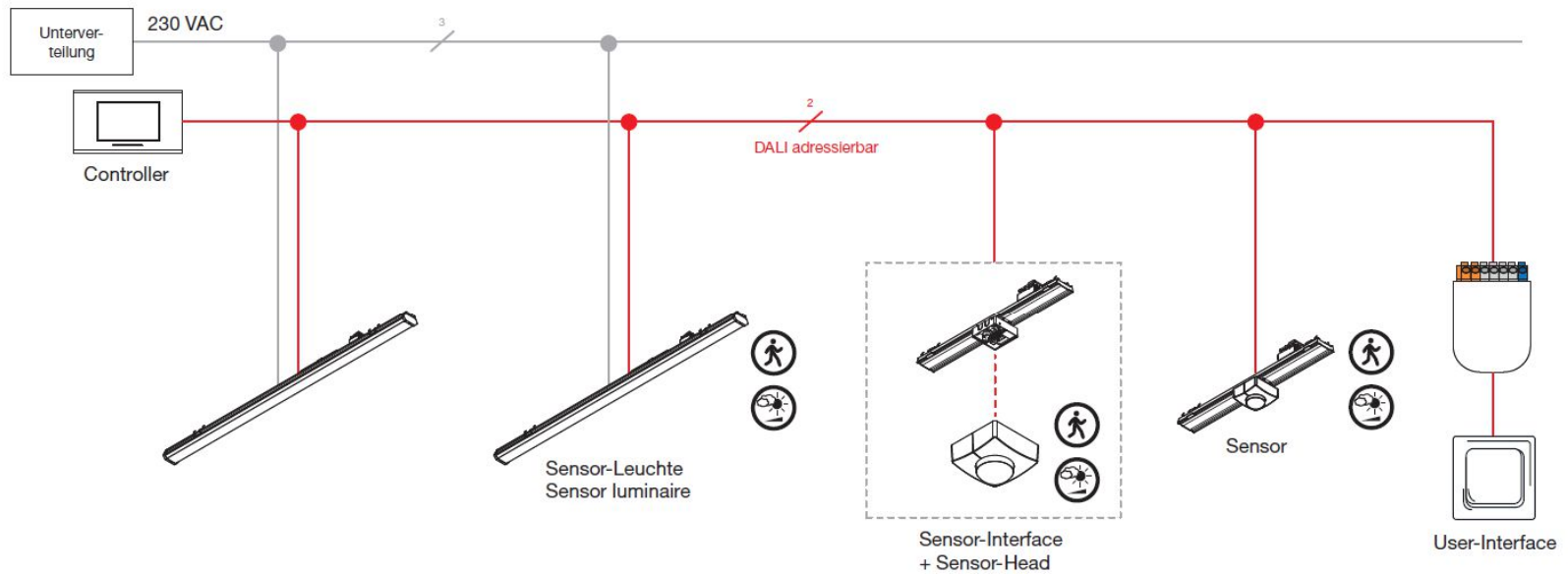

Die obige Darstellung zeigt nur einen exemplarischen Schaltplan eines Lichtmanagementsystems. Für einen konkreten Anwendungsfall ist zwingend eine individuelle Planung (insbesondere Leitungs- und Stromkreisdimensionierungen, Leitungsarten, Brandschottungen, Trassenführungen, etc.) durch qualifiziertes Personal erforderlich. Die Siteco GmbH übernimmt keinerlei Haftung für die Richtigkeit der obigen Darstellung

The illustration above only shows an exemplary circuit diagram of a light management system. For a specific application, individual planning (in particular line and circuit dimensions, line types, fire barriers, cable routing, etc.) a qualified personnel is essential. The SITECO GmbH assumes no liability for the correctness of the above representation.

1.2 Shelf/high bay storage system

SITECO Connect 22

Stromlaufplan/wiring diagram

SITECO Connect 22

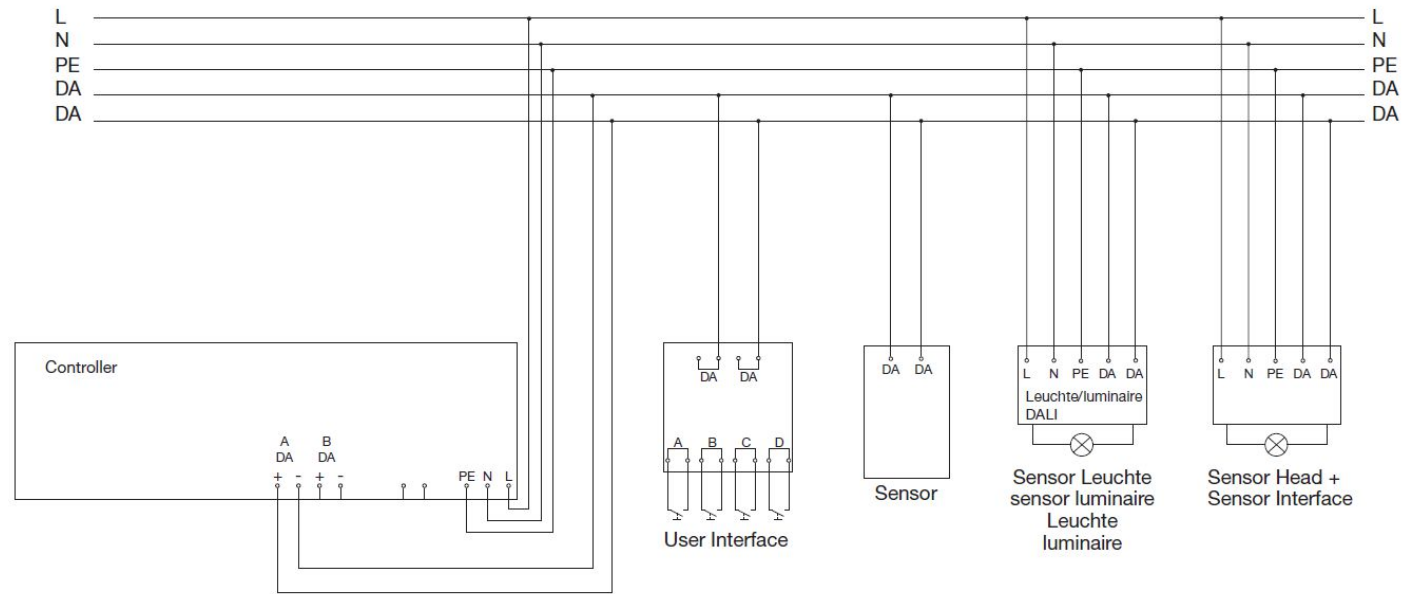

Die obige Darstellung zeigt nur einen exemplarischen Schaltplan eines Lichtmanagementsystems. Für einen konkreten Anwendungsfall ist zwingend eine individuelle Planung (insbesondere Leitungs- und Stromkreisdimensionierungen, Leitungsarten, Brandschottungen, Trassenführungen, etc.) durch qualifiziertes Personal erforderlich. Die Siteco GmbH übernimmt keinerlei Haftung für die Richtigkeit der obigen Darstellung

The illustration above only shows an exemplary circuit diagram of a light management system. For a specific application, individual planning (in particular line and circuit dimensions, line types, fire barriers, cable routing, etc.) a qualified personnel is essential. The SITECO GmbH assumes no liability for the correctness of the above representation.







Example 1.1

**Shelf/ high-bay
warehouse**

Licross® trunking

**central control
SITECO Connect 11**

1.1 Shelf/high bay storage SITECO Connect 11

- 
Efficiency through integrated energy-saving basic functions
- 
Safety through sensors with high detection quality
- 
Modularity and **freedom** in planning thanks to the Licross® family concept
- 
Retrofittability through modular sensor interfaces in existing systems
- 
Future-proof through the use of open Standards
- 
 Maximum **flexibility** through individual addressing, thus adaptation to changing needs.
- 
 Central control and monitoring functions enable **dashboards** on plant status.

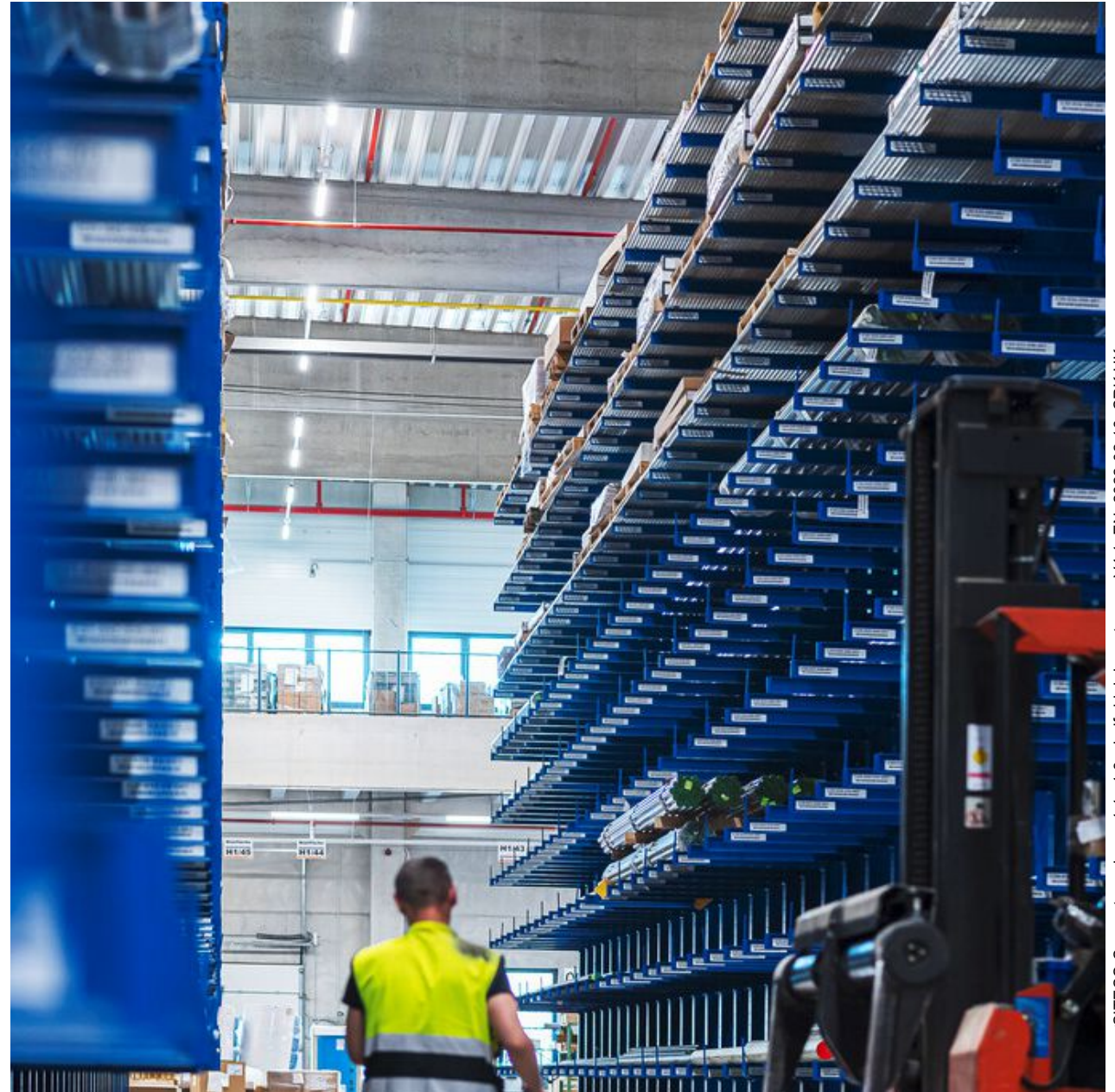

1.1 Shelf/high bay storage system SITECO Connect 11

Example (LPH = 14m, length = 60m, width = 4m)

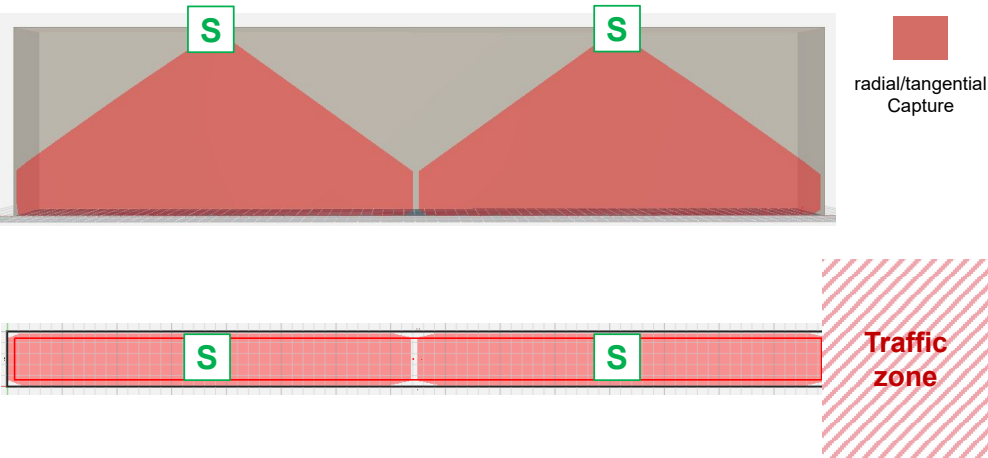

Keep in mind when planning:

- **S** = immediate detection on entry or entry
- no detection of cross traffic on traffic zone

For other mounting heights, please refer to the table of mounting heights!

Which products are needed?

Components	Function	Order no.
Licross® luminaire DALI & rail		specific
Licross® Sensor Interface + Sensor Head PR2-S	DALI 2	56TL1FCSA 59US1HXSPR2A
SITECO Connect 11 basic package with TouchPanel	S/P (1-12 DALI lines) M/P (1-18 DALI lines)	5LZ930101 5LZ930103
SITECO Connect 11 basic package with top hat rail PC	S/D (1-12 DALI lines) M/D (1-18 DALI lines)	5LZ930100 5LZ930102
Push-button interface 4-fold, 4 DI	DALI 2	5LZ930303

Services

		Order no.
Addressing / linking luminaire	per EVG address	5LZ930D00
Addressing / linking sensor	per sensor	5LZ930D01
Overnight flat rate	Hotel costs	5LZ930D03
Travel / Travel expenses	per km ex. Verl	5LZ930D04
System Technician / Direction Work	per hour	5LZ930D02

SITECO Connect 11 - maximum system sizes

# DALI ECG	max. 63 per DALI 2 line
# Sensors	max. 30 per DALI 2 line (Attention, observe current consumption! Max. Output current of the DALI control must not be exceeded!)

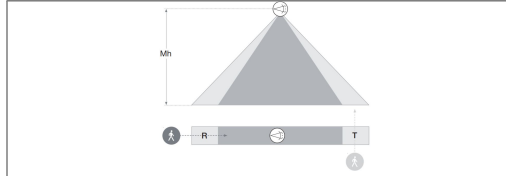

Designation	MH	R	T
PR2 (Relux-Article-#010591)	14m	30x4m	30x4m
	12m	30x4m	30x4m
	10m	25x4m	25x4m
	8m	20x4m	20x4m
	6m	15x4m	15x4m
	4m	10x4m	10x4m

Sub-distribution
SITECO Connect 11 control with DALI 2 interface

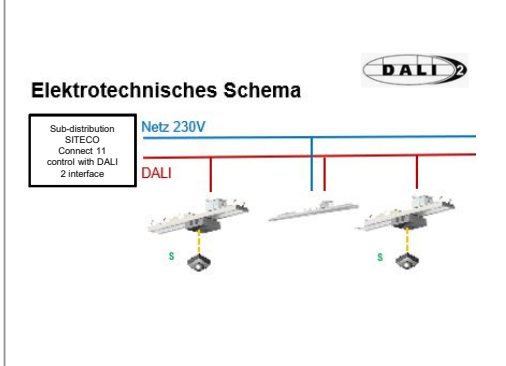

1.1 Shelf/high bay storage system

SITECO Connect 11

Siteco Connect 11

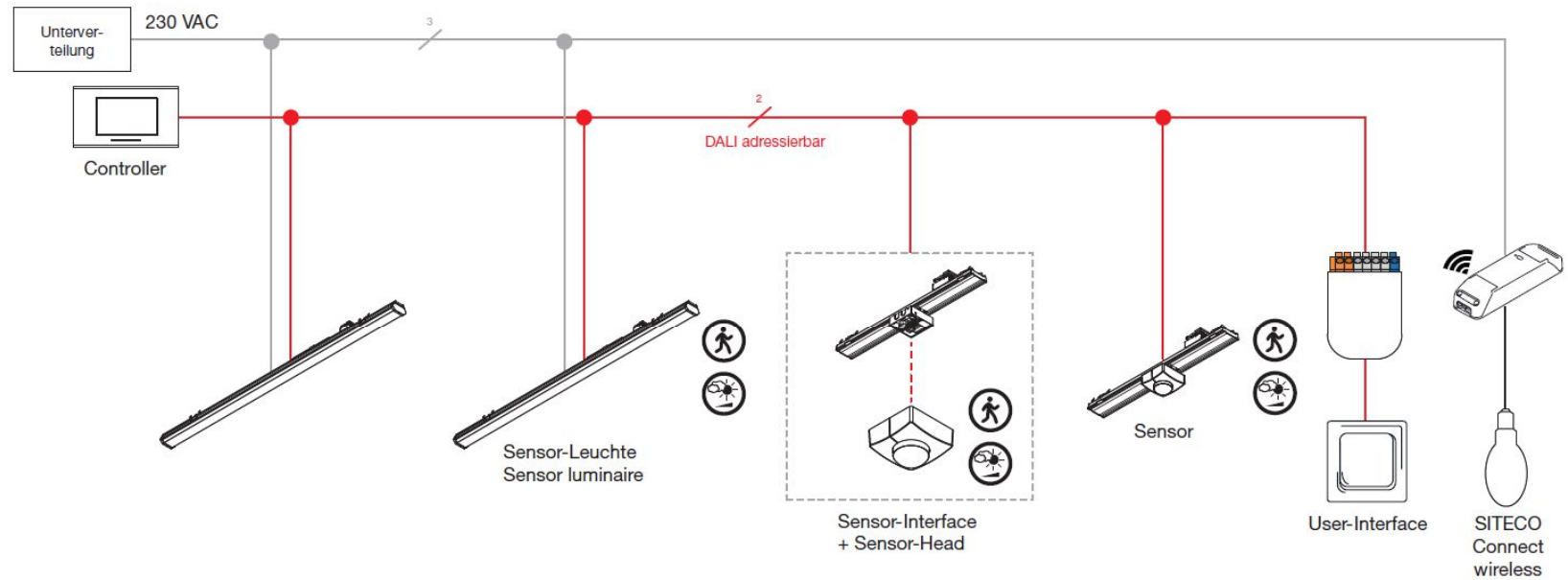

Die obige Darstellung zeigt nur einen exemplarischen Schaltplan eines Lichtmanagementsystems. Für einen konkreten Anwendungsfall ist zwingend eine individuelle Planung (insbesondere Leitungs- und Stromkreisdimensionierungen, Leitungsarten, Brandschottungen, Trassenführungen, etc.) durch qualifiziertes Personal erforderlich. Die Siteco GmbH übernimmt keinerlei Haftung für die Richtigkeit der obigen Darstellung

The illustration above only shows an exemplary circuit diagram of a light management system. For a specific application, individual planning (in particular line and circuit dimensions, line types, fire barriers, cable routing, etc.) a qualified personnel is essential. The SITECO GmbH assumes no liability for the correctness of the above representation.

1.1 Shelf/high bay storage system

SITECO Connect 11

Stromlaufplan/wiring diagram

SITECO Connect 11

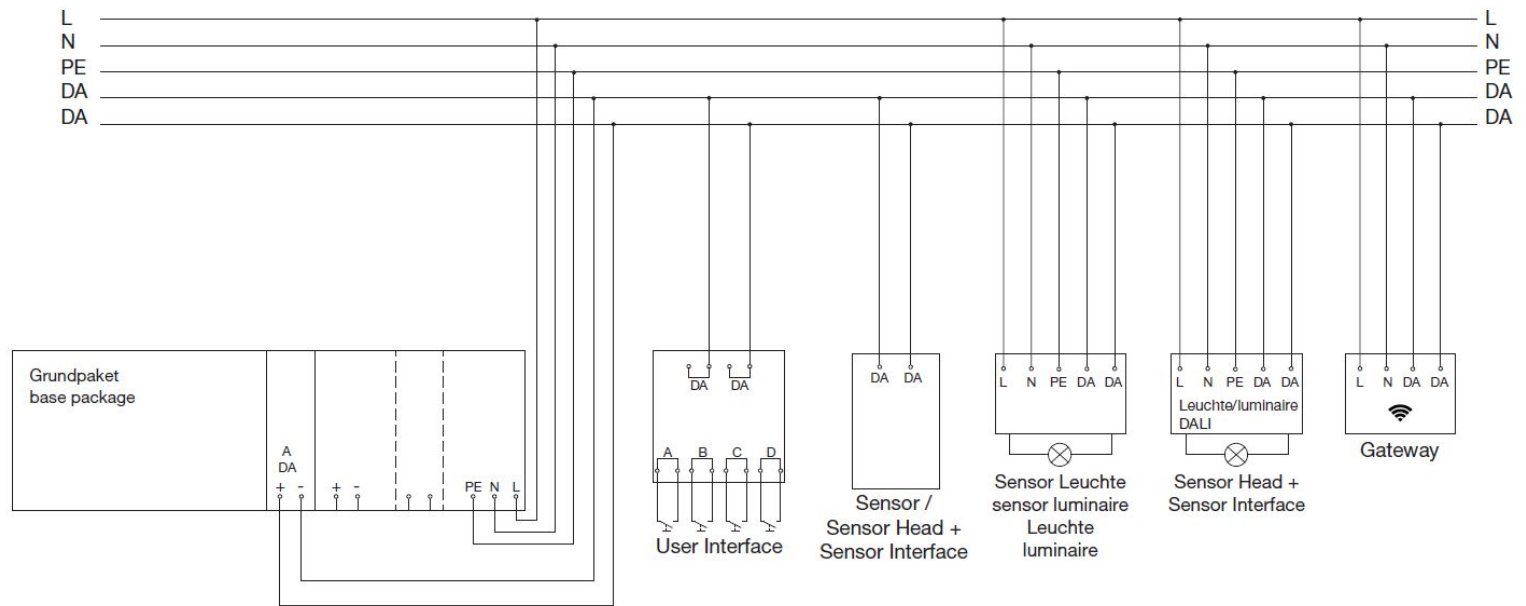

Die obige Darstellung zeigt nur einen exemplarischen Schaltplan eines Lichtmanagementsystems. Für einen konkreten Anwendungsfall ist zwingend eine individuelle Planung (insbesondere Leitungs- und Stromkreisdimensionierungen, Leitungsarten, Brandschottungen, Trassenführungen, etc.) durch qualifiziertes Personal erforderlich. Die Siteco GmbH übernimmt keinerlei Haftung für die Richtigkeit der obigen Darstellung

The illustration above only shows an exemplary circuit diagram of a light management system. For a specific application, individual planning (in particular line and circuit dimensions, line types, fire barriers, cable routing, etc.) a qualified personnel is essential. The SITECO GmbH assumes no liability for the correctness of the above representation.